

GENERAL PURPOSE, 1/3R, COLOR: WHITE.

FOR SCHEMATIC SEE DWG# 26736

APPROX WT: 755LBS

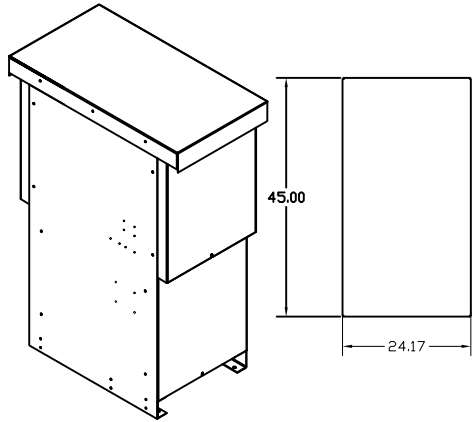

**KMG HIGH PERFORMANCE OUTPUT FILTER**  
 PART NUMBER: KMG600AG3R0000  
 FLA: 600 DRAWING#: 103447DG  
 SYSTEM VOLTAGE: 480V SCHEMATIC: 26736  
 HZ: 60  
 PHASE: 3 ENCLOSURE TYPE: 1/3R  
**MOTORGUARD**

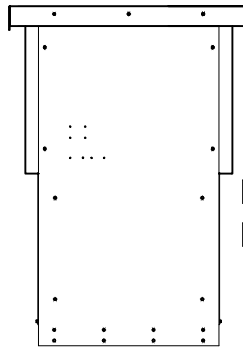
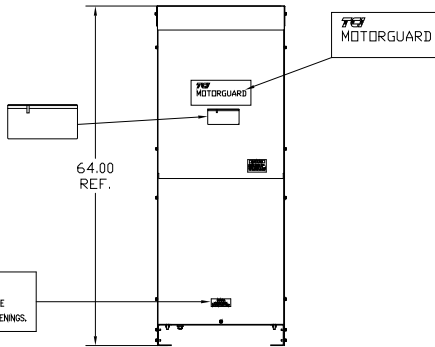
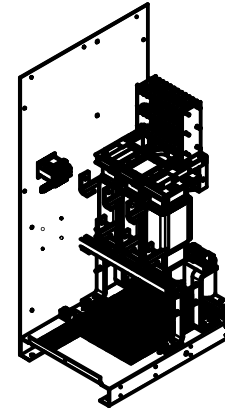
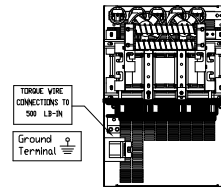

T1 T2 T3  
 U V W

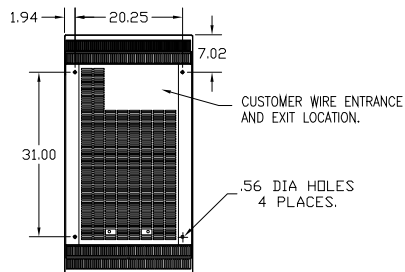
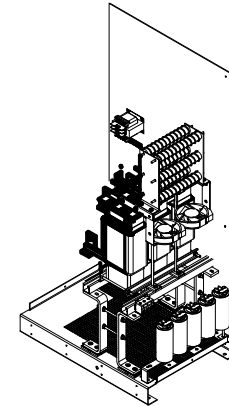
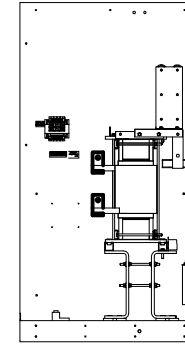
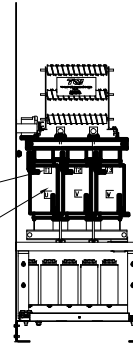

PART NUMBER: KMG600AG3R0000

CUSTOMER IS RESPONSIBLE FOR INSTALLATION TO MEET ALL NATIONAL AND LOCAL ELECTRICAL CODES.

		TOLERANCES EXCEPT AS NOTED:		 V132 N10611 GRANT DRIVE GERMANTOWN, WI. 53022
		DECIMAL		
		.XX ± .02 .XXX ± .01		
		FRACTIONAL		KMG, LRC FILTER, STANDARD 600AMP, 480/3/80, 1/3R
		± 1/32		
C 2818	CHG ENG DEPTH	4/2/2012	DSW	DRN BY DSW DATE 08/06/08 SCALE TO FIT
NO	REVISION	DATE	BY	DWG NO. 103447DG SHT. 1 OF 1